



**DO NOT DISCARD!**

MAKE ACCESSIBLE TO ALL PERSONNEL INVOLVED  
IN THE CARE AND USE OF POWER TOOLS.

00001676\_R8

# PNEUMATIC TOOL SAFETY & OPERATING GUIDELINES



SECTION	PAGE
Safety - Signal Words/Symbols .....	2
General - Warnings/Cautions .....	3-6
Grinder - Warnings .....	7-9
Die Grinder - Warnings .....	10
Router - Warnings.....	11-12
Sander/Polisher - Warnings/Cautions.....	12-13
Drill - Warnings/Cautions.....	14
Power Brush - Warnings/Cautions.....	15-16
Reciprocating - Warnings/Cautions.....	17
Percussive - Warnings/Cautions .....	18
Threaded Fastener - Warnings/Cautions .....	18-19

# GENERAL AND TOOL SPECIFIC SECTIONS MUST BE READ AND UNDERSTOOD BEFORE OPERATING ANY PORTABLE PNEUMATIC TOOL!

This document must be read and understood by operating personnel and safety manager. Protection to operating personnel, as well as adjacent areas, shall be maintained at all times. The user and/or the user's employer shall conduct a risk assessment of workplace hazards including exposure limits.

ALWAYS COMPLY WITH: General Industry Safety & Health Regulations ([www.osha.gov](http://www.osha.gov)), International Organization for Standardization ([www.iso.org](http://www.iso.org)) and Regional Regulations. EN Standards for Hand Held Non-Electric Power Tools ([www.cen.eu](http://www.cen.eu)), American National Standards Institute ([www.ansi.org](http://www.ansi.org)), Compressed Air and Gas Institute ([www.cagi.org](http://www.cagi.org)).

+ **ADDITIONAL SAFETY REFERENCE MATERIALS ARE AVAILABLE AT [WWW.DYNABRADE.COM](http://WWW.DYNABRADE.COM)**

## SAFETY SIGNAL WORDS



Indicates a hazardous situation that, if not avoided, will result in death or serious injury. This signal word is to be limited to the most extreme situations.



Indicates a hazardous situation that, if not avoided, could result in death or serious injury.



Indicates a hazardous situation that, if not avoided, could result in minor or moderate injury. It may also be used without the safety alert symbol as an alternative to "NOTICE."



Is the preferred signal word to address practices not related to personal injury. The safety alert symbol shall not be used with this signal word. As an alternative to "NOTICE", the word "CAUTION" without the safety alert symbol may be used to indicate a message not related to personal injury.

## SAFETY SYMBOLS

Dynabrade Inc. safety labels/symbols follow the guidelines outlined in ISO 7010. In order to help users understand the meaning of the safety labels/symbols, the standard allows the reproducing of the figures and captions below. A complete color version may be found at [www.dynabrade.com](http://www.dynabrade.com).

### Geometric surround shapes:



**WARNING** - A black graphical symbol inside a yellow triangle with a black triangular band defines a safety sign that indicates a hazard.



**PROHIBITION** - A black graphical symbol inside a red circular band with a red diagonal bar defines a safety sign that indicates that an action shall not be taken or shall be stopped.



**MANDATORY ACTION** - A white graphical symbol inside a blue circle defines a safety sign that indicates that an action shall be taken to avoid a hazard.

For consistency Dynabrade Inc. also uses the above symbols and word definitions in collateral material, which includes this Pneumatic Tool Safety Guidelines. For product safety information in Product Manuals, Instructions, and other Collateral Materials, Dynabrade Inc. adheres to ANSI Z535.6-2006.



Refer to Instruction Manual/Booklet



Hearing Protection must be worn



Eye Protection must be worn



Respiratory Protection must be worn



Electric Shock Hazard



Safety Alert



Vibration Hazard



Air Hose Hazard



Fire Hazard



Entanglement Hazard



Explosion Hazard















Crush Hazard



E.S.D. (Electrostatic Discharge)











## GENERAL - ALL TOOLS



- 3.1.1  Always wear personal protective equipment. User of tool is responsible for following regional safety regulations. For overhead work, wear a safety helmet.
- 
- 3.1.2  Some dust and fumes created by sanding, grinding, drilling, and other construction activities contain chemicals known to cause cancer, birth defects or other reproductive harm.  
Some examples are:  
- Lead from lead-based paints  
- Crystalline silica from bricks, cement and other masonry products  
- Arsenic and chromium from chemically treated lumber  
Your risk from these exposures varies, depending on how often you do this type of work. To reduce your exposure to these chemicals: work in a well ventilated area, and work with approved safety equipment, vacuum tools and dust masks specially designed to filter out microscopic particles.
- 
- 3.1.3 Creation of or disturbance of existing dust may be hazardous.  
*Airborne dust and fumes may be harmful to respiratory health.*  
Collect dust and/or fumes at the point of emission through use of extraction, suppression or integrated features. Direct the exhaust to minimize disturbance of dust.
- 
- 3.1.4  Only qualified and trained operators should install, adjust or use a power tool.
- 
- 3.1.5   Operating a tool with spindle speed exceeding rated speed may be hazardous.  
*A tool operating with spindle speed exceeding rated speed may cause accessory product to explode or malfunction, resulting in injury or death.*  
Tool must be tested. Check spindle speed of tool regularly with 90 PSIG (6.2 Bar) at tool inlet without accessory mounted. Unless otherwise stated the no-load speed may not exceed the rated speed.
- 
- 3.1.6   Accessories running at speeds greater than manufacturer rating may be hazardous.  
*Operating accessories above their rated speed may cause malfunction or excessive vibration.*  
Tool speed must never exceed accessory speed rating. Check accessory manufacturer for details on maximum operating speed or special mounting instructions.
- 
- 3.1.7  Carrying tools by air hose may be hazardous.  
*Tools may accidentally start and cause injury, or damage to tool or accessory.*  
**DO NOT carry tool by air hose.**
- 
- 3.1.8 **Tools are intended to be turned on to do work. After work is complete turn tool off.**
- 
- 3.1.9  Tools may cause hazardous situations.  
*Improper use of tool could cause injury or death.*  
**Read and understand all instructions before operating/servicing any Dynabrade product.**
- 
- 3.1.10  Damaged tools and accessories may cause hazardous situations.  
*A tool or accessory that has been dropped or damaged by mishandling may not be able to withstand pressurized air.*  
**Always visually inspect tool and accessory before use. DO NOT use tool if it appears damaged. DO NOT use an accessory that has been dropped.**
- 
- 3.1.11  Tools and the work they perform may produce hazardous sound levels.  
*Hearing damage and loss of hearing may result when not wearing proper hearing protection.*  
**Approved hearing protection must be worn when exposure to sound exceeds regional limits.**
- 
- 3.1.12  Flying particles and debris may be discharged when operating tools.  
*High velocity particles and debris may cause injury or death.*  
**Approved personal protective equipment including impact resistant eye protection must be worn at all times. The grade of protection required should be assessed for each use.**













# GENERAL - ALL TOOLS



- 4.1.1  Illegible or missing specification markings may be hazardous.  
*Illegible or missing specifications do not provide necessary tool identification, which may lead to injury or death.*  
**Specification markings must be kept legible at all times. Employer is responsible for maintaining specification information.**
- 
- 4.1.2   Modifying tools may create hazardous situations.  
*Operating modified tools may cause injury or death.*  
**DO NOT modify Dynabrade products, they must be used as intended.**
- 
- 4.1.3  **DO NOT allow the inserted accessory to chatter on the workpiece, as this is likely to cause a substantial increase in vibration.**
- 
- 4.1.4 **Cold air shall be directed away from the hands.**
- 
- 4.1.5  **If tool has silencer, always ensure that it is in place and in good working order.**
- 
- 4.1.6   Operating tool with air inlet pressure greater than tool's PSIG (Bar) rating will increase tool speed.  
*Operating accessories above the rated speed indicated by manufacturer may cause malfunction or excessive vibration.*  
**DO NOT expose air tool to inlet pressure above tool's PSIG (Bar) rating.**
- 
- 4.1.7  Tools and moving parts create vibration.  
*Vibration may cause disabling damage to the nerves and blood supply of the hands and arms.*  
**Limit exposure to vibration based on regional guidelines. Wear warm clothing when working in cold conditions and keep hands warm and dry. If discomfort occurs stop using the tool, notify supervisor and consult physician.**
- 
- 4.1.8  Accessories not properly mated with tools may cause a hazard.  
*Use of improperly sized or type of accessory may cause excessive vibration or create an unstable working environment.*  
**Follow tool specifications before choosing size and type of accessory.**
- 
- 4.1.9 **Operators and maintenance personnel shall be physically able to handle the bulk, weight, and power of the tool. Work in a well-lit organized environment with firm footing and good posture.**
- 
- 4.1.10 **Improper use of a tool or use of a poorly maintained tool or accessory may create a hazard.**  
*Poorly maintained tool or accessory could cause reduced power, performance, or unsafe conditions; unnecessary vibration, noise, dust or fumes may be generated which may cause injury or death.*  
**Properly select, use and maintain tool and accessories. Use only recommended lubricants.**
- 
- 4.1.11 **Guards shall be securely in place and in good functional condition. Damaged, bent or severely worn guards shall be replaced with the tool manufacturer's recommended guards.**
- 
- 4.1.12 **Applying excessive force to accessory or tool may be hazardous.**  
*Using excessive force may lead to lack of control, increased vibration, or component failure, which may cause injury or death.*  
**DO NOT use excessive force.**
- 
- 4.1.13   Use of a damaged or defective accessory is hazardous.  
*Damaged or defective accessories may fail, detach or increase vibration.*  
**Inspect accessories for damage or defects prior to installation on tools.**
- 
- 4.1.14 **Worn accessories require excessive force and may be hazardous.**  
*Compensating for a worn accessory with excessive force may cause the accessory to fail, which may cause injury or death.*  
**DO NOT use worn or damaged accessories.**

# GENERAL - ALL TOOLS









- 5.1.1 Unintentional tool starting may create a hazard.  
*If throttle is activated as tool is connected to air supply, tool operation will begin immediately.*  
**DO NOT activate throttle when connecting tool to air supply.**
- 
- 5.1.2 Tools attached to air supply may start unintentionally, creating a hazard.  
*Unintentional tool starting may cause injury or death.*  
**Fully depressurize air supply when tool is idle or when changing accessories.**  
**All tool maintenance must be done with tool disconnected from air supply.**
- 
- 5.1.3 If throttle remains activated during an interruption to air supply; tool operation will begin immediately when air supply resumes.  
*Unintentional tool stop and start may cause injury or death.*  
**Release throttle lever in the case of an interruption to air supply. Put in off position.**
- 
- 5.1.4 Altering a tool so that it remains in the ON position may be hazardous.  
*Injury or death may occur as a result of not being able to turn the tool OFF in case of a sudden emergency.*  
**DO NOT alter or lock tool in the ON position.**
- 
- 5.1.5 Setting a tool down while it is still in motion may create a hazard.  
*Setting a tool down while it is still in motion may cause it to move uncontrollably and may cause injury or death.*  
**Never set a tool down while it is still in motion.**
- 
- 5.1.6 Operating tools when fatigued or under the influence of alcohol or drugs is hazardous.  
*Injury or death may occur.*  
**DO NOT operate tools when fatigued or under the influence of alcohol or drugs.**
- 
- 5.1.7 If tool is equipped with a reverse mechanism, be aware of the direction of rotation before operating tool.
- 
- 5.1.8  A tool with a malfunctioning, modified or removed governor may create a hazard.  
*Operating a tool with a missing or malfunctioning governor may cause injury or death.*  
**DO NOT modify or remove tool's governor.**
- 
- 5.1.9  Tool is not insulated against contact with electric power. Tools coming in contact with electrical power may be hazardous.  
*Electrical power may cause injury or death.*  
**DO NOT contact electrical power, either exposed or hidden.**
- 
- 5.1.10   Ensure that there are no electrical cables, gas pipes, etc., which can cause a hazard if damaged by use of the tool.
- 
- 5.1.11   Tools used in flammable or explosive environments may be hazardous.  
*Sparks and debris may lead to fire or explosions which may cause injury or death.*  
**DO NOT use tools in flammable or explosive environments.**
- 
- 5.1.12   Explosive atmospheres may create hazardous situations.  
*Sanding and grinding creates dust and fumes which may create an explosive atmosphere causing injury or death.*  
**Always use dust extraction or suppression systems which are suitable for the material being processed.**
- 
- 5.1.13  A workpiece that is not secured properly may be hazardous.  
*A improperly secured workpiece may move, fall or create excessive noise; causing injury or death.*  
**Use a vise or clamping device to secure workpiece. Put appropriate clamp in such a way as to dampen work piece to lessen noise hazard of "ringing".**
- 
- 5.1.14   Failure of the workpiece, accessories or even the inserted tool can generate high-velocity projectiles which may create a hazard.  
*High velocity projectiles may cause injury or death.*  
**Always wear personal protective equipment including impact resistant eye protection when operating tools. The grade of protection required should be assessed for each use.**
- 
- 5.1.15  Unattended tools may be hazardous.  
*An unqualified person may operate an unattended tool.*  
**DO NOT leave tools unattended, store in a safe, secure place.**

## GENERAL - ALL TOOLS



**WARNING**

- 6.1.1  Use only recommended fittings and air line sizes. Air hose assemblies must have a minimum working pressure rating of 150 PSIG (10 Bar), or 150 percent of the maximum pressure produced in the system, whichever is higher. (See Tool Specification Table.)
- 6.1.2 Whenever universal twist couplings (claw couplings) are used, lock pins shall be installed and whipcheck safety cables shall be used to safeguard against possible hose-to-tool or hose-to-hose connection failure.
- 6.1.3  Pressurized air supply hoses and fittings may be hazardous.  
*Injury or death may occur from free discharge of pressurized air or a whipping hose.*  
**DO NOT use damaged, frayed or deteriorated air hoses and fittings. Always check for damaged or loose hoses and fittings.**
- 6.1.4 **Never direct high pressure air at yourself or anyone.**
- 6.1.5   Low flash point chemicals may be hazardous.  
*Chemicals with a low flash point may ignite and cause injury or death.*  
**DO NOT clean or maintain tools with chemicals that have a low flash point.**
- 6.1.6 Accessories that have been rapidly cooled may create a hazard.  
*Rapidly cooling a hot accessory may make it brittle and cause it to fail in an unexpected manner causing injury or death.*  
**Never rapidly cool a hot accessory by immersing in a liquid.**
- 6.1.7  Use of non-Dynabrade parts may be hazardous.  
*Non-Dynabrade parts may fail prematurely and cause injury or death.*  
**Use only genuine Dynabrade replacement parts.**
- 6.1.8  Tools in operation have exposed moving parts which may be hazardous.  
*Placing body, clothing or jewelry near exposed moving parts of tool may have the potential to cut, sever or choke.*  
**Always direct moving parts of tool away from operator. Avoid body contact with exposed moving parts of tool, and properly secure loose clothing, hair and jewelry.**
- 6.1.9 Tools can create hazardous reaction torque at start-up and in use.  
*Reaction torque may cause the tool to twist, which may cause injury or death.*  
**When provided always use side handle or additional hand grip to stabilize reaction torque.**
- 6.1.10 When servicing tool take precautions to avoid exposure to hazardous substances that may remain deposited on tool due to work processes. NOTE: Skin exposure to hazardous dust can cause severe dermatitis. If dust is generated or disturbed during the maintenance procedure, it can be inhaled.
- 6.1.11 When a second handle is provided for the tool, ensure it is properly fastened. Use two hands to control and operate tool.

## GENERAL - ALL TOOLS



**CAUTION**

- 6.1.12 Repetitive motions may be hazardous.  
*Injuries may result from repetitive work and motion.*  
**Limiting repetitive motion may reduce potential for injury. If discomfort occurs notify supervisor and consult a physician.**
- 6.1.13 Cluttered or slippery work areas may be hazardous.  
*Cluttered or slippery work areas may cause tripping or slipping, and impair visibility.*  
**Make sure that work area provides firm footing, is uncluttered and bystanders are at a safe distance.**
- 6.1.14 During use air tools and accessories may become hot or cold. Protect against contact with hot or cold surfaces by using well fitted gloves.
- 6.1.15 **To avoid burns and/or cuts never touch an accessory immediately after use.**
- 6.1.16 The use of air tools can expose the operator's hands to hazards including crushing, impacts, cuts and abrasions and heat. Wear suitable gloves to protect hands.
- 6.1.17 Improperly suspended/supported tools may be hazardous.  
*Tools not properly secured may fall and injure operator or bystander.*  
**When using a suspension/support make certain tool is properly attached.**
- 6.1.18 Proper storage of tools and accessories should protect against water, solvents, high humidity, corrosive environment, freezing temperature or extreme temperature changes.

# GRINDER – STRAIGHT-LINE, ANGLE & VERTICAL

















**WARNING**

**OPERATOR MUST FOLLOW ALL General Safety Warnings/Cautions PG 2-6**

**TOOL INTENT:**

Straight-line, Angle and Vertical grinders are intended to be used by professional operators for a variety of material removal and cutting applications. For model specific information refer to the parts page found at [Dynabrade.com](http://Dynabrade.com).





- 7.1.1
- 7.1.2  Dispose of tool in a responsible manner following regional guidelines.
- 7.1.3 **Never mount a grinding wheel onto a power tool that is not specifically designed for that wheel type.**
- 7.1.4  A wheel guard that has withstood a wheel breakage may not provide adequate protection.  
*Operating a grinder with a wheel guard that has withstood wheel breakage may lead to injury or death.*  
**Always replace a wheel guard after a wheel breakage.**
- 7.1.5  Operating a grinder with a damaged or improperly mounted wheel guard may be hazardous.  
*A damaged or improperly mounted guard will not provide adequate protection.*  
**Ensure guard is in undamaged condition, securely fastened and the opening is positioned away from operator.**
- 7.1.6  Operating a damaged or defective abrasive product may be hazardous.  
*A damaged or defective abrasive product may explode and may cause injury or death.*  
**Inspect the abrasive product for chips, cracks or defects before use. DO NOT use an abrasive product that has been dropped. Store and handle abrasive products according to manufacturers' instructions.**
- 7.1.7   Operating a tool with a worn or damaged spindle thread may be hazardous.  
*An improperly mounted abrasive may explode or disengage which may cause injury or death.*  
**Check spindle thread for wear or damage. Replace spindle if worn or damaged.**
- 7.1.8  Mounting a cone or plug wheel on a spindle that is too long is hazardous.  
*A cone or plug wheel may be easily damaged by the spindle end, causing the wheel to explode during operation.*  
**Cone or plug wheels must be mounted on tools designed for their use. Cone or plug wheels must thread freely onto spindle and secure against spindle flange.**
- 7.1.9   Use of flanges that are not specific to the tool model may be hazardous.  
*Proper flanging is critical to ensure wheel retention and to avoid wheel damage.*  
**Only use model specific Dynabrade flanges.**
- 7.1.10   Damaged or poorly maintained flanges may be hazardous.  
*Damaged or poorly maintained flanges may not properly secure wheel or cause wheel damage.*  
**Always inspect flanges before use. The flanges must be clean and free from blotter residue. Flanges must be free from excessive wear, cracks, burrs, and run true. DO NOT use damaged or warped flanges.**
- 7.1.11  Mounting a grinding wheel without a required blotter may be hazardous.  
*Not using required blotters may fracture the abrasive and cause injury or death.*  
**Always use blotters when required between each flange and abrasive wheel to ensure uniform distribution of flange pressure. New blotters must be used each time a wheel is mounted. Blotters are provided with the abrasive product.**
- 7.1.12  Use of an incompatible abrasive wheel on a tool may create a hazard.  
*An incompatible abrasive wheel may not be properly secured or damaged which may lead to disengagement or explosion of the abrasive wheel.*  
**Ensure abrasive wheel size is compatible with grinder and fits the guard, spindle and flanges. DO NOT force a wheel onto the machine or alter the size of the mounting hole. The wheel should freely slide onto the spindle. DO NOT use bushings or adapters to mount wheels.**
- 7.1.13  Operating on the side of a grinding wheel or cut-off wheel may be hazardous.  
*Grinding on the side of a grinding wheel or cut-off wheel may cause the wheel to explode, which may cause injury or death.*  
**DO NOT grind on the side of the grinding wheel or cut-off wheel.**

# GRINDER – STRAIGHT-LINE, ANGLE & VERTICAL



**WARNING**

## OPERATOR MUST FOLLOW ALL General Safety Warnings/Cautions PG 2-6

- 8.1.1  Improper mounting of an abrasive wheel may be hazardous.  
*Abrasive wheels that are not securely fastened may spin off the tool, which may cause injury or death.*  
Ensure the abrasive wheel is properly mounted and tightened before use, **DO NOT** over tighten. Run power tool at free speed for 1 minute in a protective area. Stop immediately if vibration and/or sound levels are abnormal. Repair and test before use.
- 
- 8.1.2  Operating an abrasive wheel improperly may be hazardous.  
*An abrasive wheel may explode during operation if used improperly which may cause injury or death.*  
**Make smooth contact with work surface. Avoid any bumping action or excessive pressure. When starting a wheel, work slowly until wheel gradually warms up.**
- 
- 8.1.3  A cut-off wheel that is pinched within the work piece may be hazardous.  
*A pinched cut-off wheel may cause erratic tool movement or fracture the wheel, which may cause injury or death.*  
**When using cut-off wheels, keep slot width constant. If wheel gets jammed in cut slot, shut off the grinder. Ease wheel from slot and inspect for wheel damage.**
- 
- 8.1.4  Improperly handling or storing a grinder with an abrasive wheel attached may be hazardous.  
*A damaged abrasive wheel may explode during operation, which may cause injury or death.*  
**DO NOT** mishandle grinder or abrasive wheel when storing a grinder with an abrasive attached. Protect the abrasive and grinder by using suitable rests, fixtures or storage cabinets.

### Proper TYPE 1 STRAIGHT WHEEL MOUNTING – Over 4" (102 mm) Diameter

*With Power Source Disconnected from the Tool, Mount Compatible Accessory*

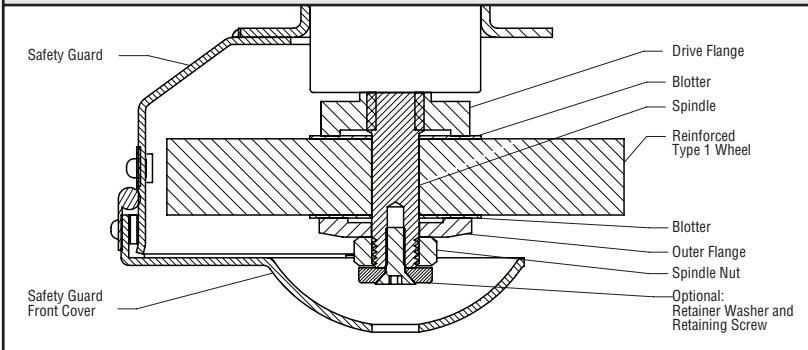

### Proper CUP WHEEL MOUNTING

*With Power Source Disconnected from the Tool, Mount Compatible Accessory*

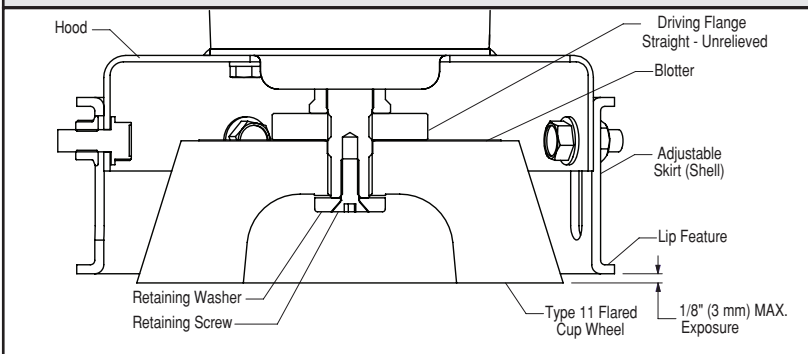



# GRINDER - REFERENCE CHART



OPERATOR MUST FOLLOW ALL General Safety Warnings/Cautions PG 2-6

Mounting Features				Guard Requirements	Diagram Proper Mounting Procedure
Abrasive Type	Abrasive Size	Driving Flange	Blotters		
	Wheels less than or equal to Ø4" (102 mm) with 3/8" (10 mm) Center hole	Requires a special support adapter that extends beyond the raised hub and contacts the wheel.	Not required	<ul style="list-style-type: none"> <li>• 180° minimum Operator Protection</li> <li>• Lip Feature</li> <li>• Lip Feature must extend past face of wheel</li> </ul>	
<b>Type 27 / 42 Reinforced Depressed Center Wheels, Flap Disc Wheels</b>	Alternate flanging for wheels less than or equal to Ø6" (152 mm) with Ø5/8" (16 mm) or Ø7/8" (22 mm) Center hole	A special support adapter may be used or straight unrelieved flange 1/3 of wheel diameter minimum	Not required	<ul style="list-style-type: none"> <li>• 180° minimum Operator Protection</li> <li>• Lip Feature</li> <li>• Lip Feature must extend past face of wheel</li> </ul>	
	Greater than Ø6" (152 mm) with 7/8" (22 mm) Center hole	Requires a special support adapter that extends beyond the raised hub and contacts the wheel.	Not required	<ul style="list-style-type: none"> <li>• 180° minimum Operator Protection</li> <li>• Lip Feature</li> <li>• Lip Feature must extend past face of wheel</li> </ul>	
<b>Type 1 Reinforced Straight Wheels</b>	Up to 4" (102 mm) diameter greater than 1/8" (3 mm) thick	Straight relieved flange 1/3 Wheel Diameter minimum	Required on both sides of wheel. Loose blotters must be replaced when mounting a new wheel.	<ul style="list-style-type: none"> <li>• 180° minimum Operator Protection</li> <li>• Lip Feature</li> <li>• Lip Feature must extend past face of wheel</li> </ul>	
<b>Type 41 (formerly Type 1 cut-off) Reinforced Straight Wheels</b>	Up to 4" (102 mm) diameter equal to or less than 1/8" (3 mm) thick	Straight relieved flange 1/3 Wheel Diameter minimum	-	<ul style="list-style-type: none"> <li>• 180° minimum Operator Protection</li> <li>• Lip Feature</li> <li>• Lip Feature must extend past face of wheel</li> </ul>	
<b>Type 16 Cone or Plug Abrasive</b>	Ø1" (25 mm) to Ø3" (76 mm)	Straight unrelieved flange. See ANSI B7.1 for proper flange diameter and thickness.	Required between flange and wheel	<ul style="list-style-type: none"> <li>• Not required where the work offers protection or where the size does not exceed Ø3" (Ø76 mm) x 5" (127 mm) long</li> </ul>	

Always refer to ANSI B7.1, CAG B186.1 and ISO 11148 for detailed requirements.

NOTE: Intended for general reference use only.

# DIE GRINDER – STRAIGHT-LINE, ANGLE & VERTICAL



OPERATOR MUST FOLLOW ALL General Safety Warnings/Cautions PG 2-6

- TOOL INTENT:** Straight-Line and Angled Die Grinders are colleted tools intended to be used by professional operators for removal and polishing of materials using deburring, cleaning and polishing accessories. For model specific information refer to the parts page found at [Dynabrade.com](http://Dynabrade.com).
- 10.1.1
- 10.1.2 Beware, that there is a running-on of the rotary inserted tool after the start-and-stop device has been released. For turbine die grinders, the stopping time can be of the order of several seconds.
- 10.1.3 Operating a die grinder with a mandrel that does not match the collet insert diameter may be hazardous.  
*A mandrel diameter that does not match the collet insert may become dislodged from the collet insert which may cause injury or death.*  
**With the air supply disconnected from the tool, tighten collet cap to ensure accessory is properly secured. Non-secured accessories must not be used.**
- 10.1.4 The distance that an accessory extends from the collet "overhang" affects the speed rating of the accessory. Excessive overhang conditions may be hazardous.  
*Overextending an accessory may cause the mandrel to bend and malfunction which may result in injury or death.*  
**Refer to accessory manufacturer's specifications on overhang. As an additional reference see ANSI B7.1 for charts showing the effects of overhang on the speed rating for various shaped accessories.**
- 10.1.5 Operating a die grinder with an inappropriate accessory may be hazardous.  
*When drill accessories break, flying particles may cause injury or death. An inappropriate accessory may cause the tool to react erratically, which may result in injury or death.*  
**DO NOT use inappropriate accessories such as grinding wheels, router bits, cut-off wheels, saws, etc. on a die grinder.**
- 10.1.6 Operating a damaged or defective abrasive mounted wheel may be hazardous.  
*A damaged abrasive mounted wheel may explode and may cause injury or death.*  
**Inspect the abrasive mounted wheel for chips, cracks or defects before use. DO NOT use an abrasive mounted wheel that has been dropped. Store and handle abrasive mounted wheel according to manufacturers' instructions.**
- 10.1.7 Poorly maintained collets or inserts may be hazardous.  
*Collet assemblies may malfunction. Collet insert may not hold or release the inserted accessory, which may cause injury or death.*  
**Regularly clean and inspect collet assembly parts for wear or damage.**
- 10.1.8 Operating mounted wheels carelessly or improperly may be hazardous.  
*Mounted wheels may explode during operation which may cause injury or death.*  
**Make smooth contact with work surface. Avoid any bumping action or excessive pressure. When starting a wheel, work slowly until wheel gradually warms up.**



## Proper GRINDER ACCESSORY MOUNTING

*With Power Source Disconnected from the Tool, Mount Compatible Accessory*

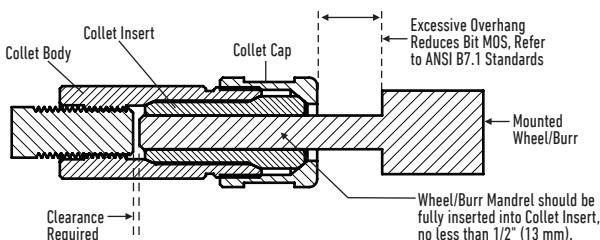

**Note:** Intended for general reference use only. Always refer to ANSI B7.1, CAGI B186.1 and ISO 11148 for detailed requirements.

# ROUTERS – STRAIGHT-LINE, ANGLE & VERTICAL



**OPERATOR MUST FOLLOW ALL General Safety Warnings/Cautions PG 2-6**

**TOOL INTENT:**

11.1.1

Routers are colleted tools intended to be used by professional operators for trimming, surface planing, beveling, cutting, and cornering on a variety of materials.  
For model specific information refer to the parts page found at [Dynabrade.com](http://Dynabrade.com).

11.1.2

Never operate a router with the base plate removed. Firmly place base plate against work piece. All guides, cam followers and shrouds must be securely tightened.

11.1.3



Operating a router with an inappropriate accessory may be hazardous.

*An inappropriate accessory may cause the tool to react erratically, which may result in injury or death.*

**Only use router bits, DO NOT use inappropriate accessories such as grinding wheels, saws or cut-off wheels.**

11.1.4

Operating a router with a mandrel that does not match the collet insert diameter may be hazardous.

*A mandrel diameter that does not match the collet insert may become dislodged from the collet insert, which may result in injury or death.*

**Only use a mandrel diameter that matches collet insert diameter.**

11.1.5

**Router bit mandrel should be fully inserted into collet, then pulled back 1/8" (3 mm) and securely tightened with provided wrenches.**

11.1.6

Poorly maintained collets or inserts may be hazardous.

*Collet assemblies may malfunction. Collet insert may not hold or release the inserted accessory, which may cause injury or death.*

**Regularly clean and inspect collet assembly parts for wear or damage.**

11.1.7

Operating a router with damaged or dull accessories may be hazardous.

*Damaged or dull accessories do not function as intended and may cause injury or death.*

**DO NOT use damaged or dull accessories.**

11.1.8

**Never use bits that have a cutting diameter larger than the opening in the router base.**

11.1.9

Operating a router at slow speed can cause "kickback" from the work piece, which may be hazardous.

*Router bits will tend to grab the work piece when they are run at slow speeds, which may result in injury or death.*

**Make sure the work piece is properly secured. Use a tachometer to ensure tool speed.**

11.1.10

Router accessories can create hazardous reaction torque.

*Reaction torque may cause the router to twist, which may cause injury or death.*

**Hold router with a firm grip before starting and during operation.**

11.1.11

Placing the work piece on top of a hard surface such as stone, concrete or steel may be hazardous.

*A protruding bit may contact the substrate and may cause the tool to jump which may cause injury or death.*

**Ensure work piece is secured to a suitable substrate.**

11.1.12

Foreign objects hidden in or on the work piece may be hazardous.

*Cutting into dissimilar materials can cause the bit and the router to jump and damage the bit, which may result in injury or death.*

**Always make sure the work surface is free from foreign objects.**

11.1.13

Starting a router when the bit is touching the work piece may be hazardous.

*A router may jerk causing the operator to lose control, which may result in injury or death.*

**Never start a router when the bit is touching the work piece.**

11.1.14

Starting a router on the end grain of a work piece may be hazardous.

*A router bit can grab the work piece, causing the operator to lose control, which may result in injury or death.*

**Never start routing end grain first. Use jigs whenever possible.**

# ROUTERS – STRAIGHT-LINE, ANGLE & VERTICAL



**OPERATOR MUST FOLLOW ALL General Safety Warnings/Cautions PG 2-6**

12.1.1

Feeding the router bit in the wrong direction may be hazardous.

*Feeding the tool in the wrong direction causes the cutting edge of the bit to climb out of the work piece and pull the tool.*

**Always feed the router bit into the work piece in the same direction as the bit rotation. See diagram.**

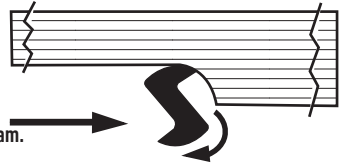

## Proper ROTARY ACCESSORY MOUNTING

*With Power Source Disconnected from the Tool, Mount Compatible Accessory*

Router Bits Ø3/8"  
(9.5 mm) mandrel max.

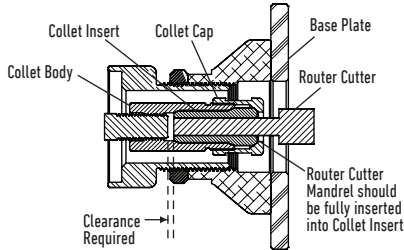

Routers MUST be used with a base plate

# SANDER/POLISHER – ROTARY, RANDOM ORBITAL, BELT SANDERS, IN-LINE



**OPERATOR MUST FOLLOW ALL General Safety Warnings/Cautions PG 2-6**

**TOOL INTENT:**

Rotary, Random Orbital, Belt & In-line Sanders and Polishers are intended to be used by professional operators for material removal and finishing on a wide array of materials utilizing a variety of abrasive media. For model specific information refer to the parts page found at [Dynabrade.com](http://Dynabrade.com).

12.1.2

12.1.3



Operating a random orbital sander (ROS) with spindle speed exceeding rated speed may be hazardous. *ROS with spindle speed exceeding rated speed may cause backup pad to explode or malfunction, or cause the abrasive to detach which may cause injury or death.*

**Check spindle speed of ROS regularly with 90 psig (6.2 Bar) at tool inlet with pad securely mounted without an abrasive. The no-load speed may not exceed the rated speed by more than 10%.**

12.1.4

Operating certain accessories on rotary sanders or polishers may be hazardous.

*Operating an accessory that requires a guard or guide device on rotary sanders or polishers does not provide an operator proper guarding or control and may cause injury or death.*

**Never mount a grinding wheel, cut-off wheel, saw or other accessories that require a guard on a sander or polisher. See manufacturers' instructions.**

12.1.5



Operating a tool with a damaged backup pad may be hazardous.

*Damaged backup pads may affect the accessory attachment, increase vibration or cause backup pad to explode, which may cause injury or death.*

**Always inspect the backup pad before installing accessory. Never use a backup pad that has been dropped or otherwise damaged.**

12.1.6

Operating a sander or polisher without the abrasive or buff in contact with the work piece may be hazardous.

*Abrasive or buff may detach and cause injury or death.*

**Never run the tool unless abrasive or buff is applied to the work piece.**

12.1.7



Electrostatic discharge (ESD) may create a hazard.







*Sanding and polishing may create an electrostatic discharge which could cause an unsafe reaction or an explosion in an explosive environment.*

**ESD must be routed past the tool operator to a safe ground. Use conductive hoses and bonding conductors in conjunction with regional/local codes to create an ESD safe working environment.**

# SANDER/POLISHER – ROTARY, RANDOM ORBITAL, BELT SANDERS, IN-LINE



## OPERATOR MUST FOLLOW ALL General Safety Warnings/Cautions PG 2-6

- 13.1.1 Use of coated abrasive belts on segmented rubber expander wheels may be hazardous.  
*Flexible coated abrasive belts may break easily and cause flying debris if used on segmented rubber expander wheels.*  
**Always use coated abrasive bands designed and recommended for segmented rubber expander wheels. Never operate a segmented rubber expander wheel without a properly mounted coated abrasive band.**
- 
- 13.1.2  Use of dirty or worn mounting face on a backup pad may be hazardous.  
*A dirty or worn mounting face may cause the accessory to detach which may cause injury or death.*  
**Always inspect mounting face of backup pad before attaching accessory to make sure it is clean and unworn.**
- 
- 13.1.3  Mounting an accessory off center on a backup pad may be hazardous.  
*Accessories mounted off center may vibrate or become detached during use and may cause injury or death.*  
**Always ensure that the accessory is centered on the backup pad.**
- 
- 13.1.4  Operating an abrasive disc that is too large for the backup pad may be hazardous.  
*An improperly mounted abrasive may explode or disengage which may cause injury or death.*  
**Never use an abrasive disc that overhangs the backup pad by more than 1/4" (6 mm).**
- 
- 13.1.5   Mounting a sanding or polishing accessory improperly may be hazardous.  
*An improperly mounted accessory may detach which may cause injury or death.*  
**Always follow manufacturers' mounting instructions when mounting an accessory.**
- 
- 13.1.6  The use of non-recommended arbors or accessories may be hazardous.  
*Non-recommended arbors or accessories may result in tool failure or erratic operation, which may cause injury or death.*  
**Use only recommended arbors or accessories.**

### Proper ROTARY SANDER ACCESSORY MOUNTING

*With Power Source Disconnected from the Tool, Mount Compatible Accessory*

- Round abrasive discs Ø9" (229 mm) max.
- Backup pad supports abrasive disc

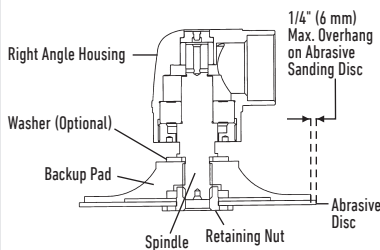

- Retaining nut secures abrasive disc
- Abrasive disc must not exceed 1/4" (6 mm) overhang

# SANDER/POLISHER – ROTARY, RANDOM ORBITAL, BELT SANDERS, IN-LINE



- 13.1.7 To avoid injury DO NOT contact moving edge of abrasive.
- 
- 13.1.8 An improperly tensioned or misaligned belt may be hazardous.  
*An improperly tensioned or misaligned belt may be ejected during operation and may cause injury.*  
**Always ensure that the sanding belt is properly tensioned and aligned before operation.**



## DRILL – STRAIGHT-LINE, PISTOL GRIP ANGLE; (HEAVY DUTY WITH 2 HANDLES)



OPERATOR MUST FOLLOW ALL General Safety Warnings/Cautions PG 2-6

**TOOL INTENT:** Drills are intended to be used by professional operators for drilling holes in a variety of materials. For model specific information refer to the parts page found at [Dynabrade.com](http://Dynabrade.com).

- 14.1.1
- 
- 14.1.2 Operating accessories not intended for use on a drill may be hazardous.  
*Many rotary type accessories require guarding, guide devices, or shrouding for safe operation. Operation of a non-recommended accessory may cause injury or death.*  
**Only use accessories specifically manufactured for use on a drill.**
- 
- 14.1.3 Some lubricants may create a hazard.  
*Some lubricants may create a fire or explosion, which may cause injury or death.*  
**Check lubricant manufacturers specifications to ensure that there is no risk of fire or explosion.**

- 14.1.4
- 
- 
- A drill accessory that breaks may be hazardous.  
*When drill accessories break, flying particles may cause injury or death.*  
**Operators and bystanders must wear proper personal protection equipment.**

- 14.1.5 **Beware of hidden hazards while drilling.**

- 14.1.6 A chuck key kept in drill chuck may be hazardous.  
*A chuck key left in a drill chuck may be thrown from tool at start-up, which may cause injury or death.*  
**Always remove chuck key after securing drill accessory.**

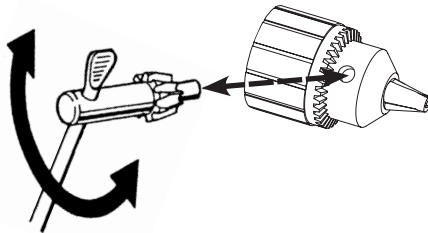

- 14.1.7 **ALWAYS REMOVE CHUCK KEY BEFORE OPERATING TOOL**



## DRILL – STRAIGHT-LINE, PISTOL GRIP ANGLE; (HEAVY DUTY WITH 2 HANDLES)









- 14.1.8 Improperly tightened accessories in drill chuck may be hazardous.  
*An accessory may detach from an improperly tightened drill chuck and cause injury.*  
**Securely tighten accessory in drill chuck before operating.**

- 14.1.9 Drill accessories may create hazardous reaction torque.  
*Reaction torque may cause injury.*  
**Side handles and reaction bars relieve the operator from reaction torque. Drills with chucks greater than Ø3/8" (10 mm) must be equipped with a secondary side handle. It is recommended to use a means to absorb the reaction torque above 4 N•m for straight tools and above 10 N•m for pistol-grip tools.**

- 14.1.10 The moving accessory of a drill may snag or become caught.  
*A moving drill accessory that snags or catches may cause tool to stop unexpectedly or move erratically, which may cause injury.*  
**Operate drill with firm footing and grip. Be prepared for snagging or unexpected movement.**

- 14.1.11 Operating a drill with a damaged or dull accessory may be hazardous.  
*Damaged or dull accessories do not function as intended and may cause injury.*  
**DO NOT use damaged or dull accessories.**

**OPERATOR MUST FOLLOW ALL General Safety Warnings/Cautions PG 2-6**

- TOOL INTENT:** Power Brush Tools (Grinders, Die Grinders and Drills) are intended to be used by professional operators for a variety of material removal, cleaning and deburring applications. For model specific information refer to the parts page found at [Dynabrade.com](http://Dynabrade.com).
- 
- 15.1.1
- 
- 15.1.2 **Power Brushes are packaged with a safety slip published by the American Brush Manufacturers Association (ABMA).**
- 
- 15.1.3  **Operators running a power brush and bystanders within 50 feet must wear safety goggles or a full-face shield worn over safety glasses with side shields along with protective clothing.**
- 
- 15.1.4 **A power brush accessory that is improperly mounted on a power tool may be hazardous.**  
*An improperly mounted power brush accessory may detach from the power tool and cause injury or death.*  
**Make sure power brush thread type and size matches the power tool spindle thread type and size. Secure power brush accessory properly before starting power tool.**
- 
- 15.1.5 **Auto threading a power brush onto a threaded arbor by running the tool may be hazardous.**  
*Attaching a thread mounted power brush by starting the power tool (auto threading) will cause the accessory to over tighten and may cause damage to the power brush which may cause injury or death.*  
**Always secure power brushes with the proper wrenches and never allow a spinning tool to auto thread the power brush to the tool.**
- 
- 15.1.6  **Improperly flanged power brush accessories may be hazardous.**  
*Modifying or using alternate flanging may cause inappropriate stress on the brush and cause it to fail, which may cause injury or death.*  
**Always use proper flanging and follow the mounting instructions that come with the brush.**
- 
- 15.1.7  **A mandrel-mounted power brush accessory that is improperly mounted in a chuck or collet may be hazardous.**  
*A brush not properly secured may become dislodged from the tool during operation and may cause injury or death.*  
**When using power brushes that are mounted by a mandrel, be sure to secure mandrel at the proper depth according to manufacturers' instructions.**
- 
- 15.1.8  **Operating a power brush with trapped debris may be hazardous.**  
*Operating a power brush accessory that contains debris may cause injury or death from flying particles.*  
**Inspect brush accessory for debris trapped inside brush accessory before use.**
- 
- 15.1.9  **Operating a tool with a worn or distorted power brush may be hazardous.**  
*A worn or distorted power brush may fail during use causing injury or death.*  
**DO NOT use power brushes with excessive wear or with distorted shape**
- 
- 15.1.10  **Loose and rusted wire filaments may be hazardous.**  
*When power brush tool is started, loose and rusted wire filament may fly out causing injury or death.*  
**Never stand in front of or in line with a running power brush accessory.**
- 
- 15.1.11 **Applying excessive force to a power brush may create a hazard.**  
*Applying excessive force may result in wire damage or breakage, which may cause injury or death.*  
**Let the brush do the work. DO NOT use excessive force.**

## POWER BRUSH TOOLS – GRINDERS, DIE GRINDERS & DRILLS



**WARNING**

### REFER TO TOOL SECTIONS FOR ADDITIONAL SPECIFIC WARNINGS/CAUTIONS

16.1.1

#### Mounting Instructions:

##### Radial Wire Brush

Radial wire brushes are mounted on the spindle of the wire brush machine with spacers as required between the driving flange and the wheel. A spindle end nut shall be threaded on the arbor to tighten the brush, if such nut is not a permanent part of brush.

##### Cup Wire Brush with Plain Holes

Cup wire brushes with plain holes are mounted on the spindle of the wire brush machine with arbor adapters. These adapters shall be of a type as recommended by the manufacturer of either the brush or the machine. A spindle end nut shall secure the brush and adapters to the spindle.

##### Cup Wire Brush with Threaded Insert

Cup wire brushes with threaded inserts are threaded on the spindle of the machine with spacers as required between the machine's driving flange and the brush. A spindle end nut may be used to further secure the brush to the spindle.

##### Mandrel Type Brushes for Mounting in Collets

The collet shall be checked to assure it to be in good condition. Threaded-on collets shall be securely seated against the driving member. To prevent excessive overhang, the mandrel shall be inserted to the full depth of the gripping jaws of the collet and the resulting overhang length of the mandrel shall be no greater than the inserted depth.

**NOTE:** Twisted-wire stems of "twisted-in" wire type brushes are not considered to be mandrels. Use of "twisted-in" wire brushes on portable air powered machines fall within the provisions of "Other Brushes". Other brushes vary widely in design, construction and materials. Because of this, safe mounting in conformance with the specific brush manufacturers' safety precautions and instructions.

## POWER BRUSH TOOLS – GRINDERS, DIE GRINDERS & DRILLS



**CAUTION**

16.1.2

When using power brushes on hand-held power tools, guards are required. Keep all machine guards in place.

16.1.3



In a protected area, run tool with brush accessory for 1 minute. Check brush for good balance by gradually increasing tool speed. DO NOT use brushes that are out of balance or vibrate.

16.1.4

Store all power brushes in protective bins to prevent bending or distorting brushes and contaminants from getting trapped inside brushes.



# RECIPROCATING – SAWS & FILES



**WARNING**

OPERATOR MUST FOLLOW ALL General Safety Warnings/Cautions PG 2-6

## TOOL INTENT:

Reciprocating tools are intended to be used by professional operators for light deburring, deflashing, cleaning, sawing and finishing on a variety of materials.  
For model specific information refer to the parts page found at [Dynabrade.com](http://Dynabrade.com).

17.1.2

Use of saw blades that are not properly sized and/or appropriate for the type of material that is to be worked may be hazardous.



*Saw blades that are not the proper length or blade type for the work material may function erratically and may cause injury or death.*

**Always use the correct length and type of saw blade for the material to be cut.  
Choose a blade length that will extend beyond work piece throughout stroke.  
Follow blade manufacturer recommendation for type selection.**

17.1.3

Using damaged or worn accessories may be hazardous.

*Premature breakage and/or loss of control may cause injury. Broken saw blades or files may cause injury or death.*

**DO NOT use accessories that are cracked or deformed.**

17.1.4

Operating a reciprocating saw with a blade that is not properly secured may be hazardous.



*A reciprocating blade that is not properly secured may dislodge or create excessive vibration, which may cause injury or death.*

**Ensure the blade is properly clamped and secure before starting work.**

17.1.5

Keys and wrenches left attached to the tool may be hazardous.



*Keys and wrenches left attached to the tool when tool is running may become projectiles which may cause injury or death.*

**Remove any adjusting key or wrench before starting tool.**

17.1.6

Reciprocating saws may be hazardous if guide plate is not kept in contact with work surface during operation.



*Operating tool without guide plate against work surface will cause excessive vibration, saw blade bending and/or breakage. This may cause injury or death.*

**Always rest guide plate in contact with work surface when starting, operating and stopping tool.**

17.1.7

Using a reciprocating saw improperly by forcing a cut or cutting an improperly supported work piece is hazardous.

*If a saw blade binds in the work piece, the tool will kickback uncontrolled and may cause injury or death.*

**Never force the saw blade into the work. Always support the work piece so it does not pinch the blade.**

17.1.8

Twisting and/or side loading files and saw blades may cause them to break.

*Broken saw blades or files may cause injury or death.*

**DO NOT twist and/or side load files or saw blades.**

17.1.9

Avoid contact with saw blade, cutter or knife whenever the energy supply is connected to the tool. Wear protective equipment, such as gloves, apron and helmet

# RECIPROCATING – SAWS & FILES



**CAUTION**

17.1.10



The motion and function of this tool produces vibration. Vibration levels may vary significantly depending on the nature of work and the accessory that is mounted on the tool. Only use recommended accessories to stay within recorded vibration values.

## PERCUSSIVE – SMALL CHISELS, ENGRAVING, PENS & FILERS

OPERATOR MUST FOLLOW ALL General Safety Warnings/Cautions PG 2-6



### TOOL INTENT:

18.1.1

Reciprocating tools are intended to be used by professional operators for engraving, light deburring, deflashing, and cleaning on a variety of materials. For model specific information refer to the parts page found at Dynabrade.com.

Never hand strike a percussive accessory. They are designed to be used only on percussive power tools.

18.1.2



Percussive accessories that are not properly secured may be hazardous.

*Improperly secured percussive accessories may dislodge and become a projectile, which may cause injury or death.*

**Never operate a tool when the percussive accessory is not properly secured. Follow mounting instructions in tool manual.**

18.1.3



Using a quick disconnect fitting at the tool inlet of a percussive tool may be hazardous.

*The action of a percussive tool may damage a quick disconnect fitting, causing it to detach. Injury or death may occur from free discharge of pressurized air or whipping hose.*

**DO NOT use quick disconnect fittings on percussive tools.**

18.1.4



Holding a percussive accessory in your free hand while tool is running is hazardous.

*Holding the percussive accessory in your free hand may be a source of vibration exposure or injury.*

**Never hold the percussive accessory while tool is running.**

18.1.5

Percussive power tools eject small particles from chipping, chiseling and filing work.

*Flying particles may cause injury to operator or bystanders.*

**Always wear proper eye and personal protection equipment.**

18.1.6



**Never operate a tool when the percussive accessory is not properly secured.**

## PERCUSSIVE – SMALL CHISELS, ENGRAVING, PENS & FILERS

Percussive accessory must be held firmly against the work surface before starting tool.



## THREADED FASTENER TOOLS – PISTOL GRIP AND STRAIGHT-LINE

OPERATOR MUST FOLLOW ALL General Safety Warnings/Cautions PG 2-6



### TOOL INTENT:

18.1.7



Threaded Fastener Tools are intended to be used by professional operators for tightening and installing threaded fasteners. For model specific information refer to the parts page found at Dynabrade.com.

**Always wear protective eye, face, hearing and body equipment while operating or near the use of any threaded fastener tool or attachment.**

18.1.8



The use of gloves when operating threaded fastener tools may be hazardous.

*Gloves can become entangled with the rotating drive, causing severed or broken fingers. Rotating drive sockets and drive extensions can easily entangle rubber coated or metal reinforced gloves.*

**Do not wear loose-fitting gloves or gloves with cut or frayed fingers.**

18.1.9



Using a quick disconnect fitting at the tool inlet of a threaded fastener tool may be hazardous.

*The action of a threaded fastener tool may damage a quick disconnect fitting, causing it to detach. Injury or death may occur from free discharge of pressurized air or whipping hose.*

**DO NOT use quick disconnect fittings on threaded fastener tools. Use hardened steel (or material with comparable shock resistance) threaded hose fittings.**

18.1.10



Operating threaded fastener tools with excessive air pressure may be hazardous.

*Excessive air pressure increases loads and stresses on the air tool parts, sockets and fastener, which may lead to wear or failure and may cause injury or death.*

**Always limit inlet air pressure to 90 PSIG (6.2 Bar) max.**

18.1.11





**Threaded fastener tools are not torque wrenches. Verify torque with a torque gauge.**

# THREADED FASTENER TOOLS – PISTOL GRIP & STRAIGHT-LINE



OPERATOR MUST FOLLOW ALL General Safety Warnings/Cautions PG 2-6



**WARNING**

- 19.1.1  Do not use in confined spaces and beware of crushing hands between tool and workpiece, especially when unscrewing.
- 
- 19.1.2 Threaded fastener tools create reaction torques that may create a hazard.  
*Reaction torque may cause injury or death.*  
It is recommended to use a suspension arm whenever possible. If that is not possible, side handles are recommended for straight case and pistol grip tools. In any case, it is recommended to use a means to absorb the reaction torque above 4 N•m for straight tools, above 10 N•m for pistol-grip tools.
- 
- 19.1.3  Use of hand tool sockets, bits and/or adapters in an assembly power tool may be hazardous.  
*Hand tool sockets, bits and/or adapters may fail and cause injury or death.*  
**Never use hand tool sockets, bits and/or adapters in a threaded fastener tool.**
- 
- 19.1.4  Damaged or poorly maintained sockets, bits and/or adapters may be hazardous.  
*Worn or damaged sockets, bits and/or adapters may slip or fracture and cause injury or death.*  
**Always inspect sockets, bits and/or adapters for wear or damage.**  
**DO NOT use worn or damaged sockets.**
- 
- 19.1.5 Operating threaded fastener tools may create an entanglement hazard.  
*Holding on to the drive, socket or drive extension while operating the fastener tools may lead to entanglement and may cause injury or death.*  
**Keep hands away from rotating drives. Never hold the drive, socket or drive extensions.**
- 
- 19.1.6 **Never hold a socket, universal joint, or other attachment in your hand while the power tool is running.**
- 
- 19.1.7 **Only use extension bars and adapters when needed. Long extension bars and adapters absorb impact power and could break loose, resulting in personal injury.**
- 
- 19.1.8 **Use only socket retaining pins designed for that purpose. Never use a make-shift pin.**
- 
- 19.1.9 **Never use spline drive anvil if the ball detent does not function properly or if the ball does not fully engage correctly into the groove of the socket.**
- 
- 19.1.10  **Never continue to hammer with an impact socket once the fastener is tight.**
- 
- 19.1.11 **Never strike an impact socket with a hammer or other hard object.**
- 
- 19.1.12 **When using a universal joint, adapter or extension bar never operate the tool off the work.**

# THREADED FASTENER TOOLS – PISTOL GRIP & STRAIGHT-LINE

- 19.1.13 When an impact or impulse mechanism fails, it may be hazardous.  
*Unexpected reaction torque may occur if the impact or impulse mechanism fails to disengage, which may cause injury.*  
**Proper tool maintenance and inspection prior to running is essential.**  
**Be prepared for unexpected tool reactions.**
- 
- 19.1.14  Assembly power tools may emit splinters, which may be hazardous.  
*Splinters generated from the use of assembly power tools may cause injury.*  
**Wear proper personal protection equipment and be cautious when using assembly power tools.**
- 
- 19.1.15 **Do not use worn or ill-fitting sockets or extensions, as this is likely to cause a substantial increase in vibration.**
- 
- 19.1.16 **Sleeve fittings should be used where practical.**
- 
- 19.1.17  **Select, maintain and replace the consumable/inserted tool when worn to prevent an unnecessary increase in vibration levels.**



**CAUTION**



## WARNING

FAILURE TO COMPLY WITH ALL SAFETY REGULATIONS MAY RESULT IN SERIOUS INJURY OR DEATH. REPETITIVE WORK MOTIONS OR EXPOSURE TO VIBRATION MAY BE HARMFUL TO YOUR HANDS AND ARMS. SOME DUST CREATED BY POWER SANDING, SAWING, GRINDING, DRILLING AND OTHER CONSTRUCTION ACTIVITIES CONTAINS CHEMICALS KNOWN TO THE STATE OF CALIFORNIA, USA, TO CAUSE CANCER, BIRTH DEFECTS OR OTHER REPRODUCTIVE HARM.



## WARNING

Cancer and reproductive Harm-  
[www.P65Warnings.ca.gov](http://www.P65Warnings.ca.gov)



### SOURCE MATERIALS

ISO 3864, ISO 7010, ANSI B7.1, ANSI Z535, ISO 11148,  
CAGI B186.1, OSHA, Power Tool Institute

### DYNABRADE, INC.

8989 Sheridan Drive | Clarence, NY 14031-1419  
PH: 716-631-0100 | US FAX: 716-631-2073 | INTERNATIONAL FAX: 716-631-2524  
US TOLL FREE: 1-800-828-7333 | CANADIAN TOLL FREE: 1-800-344-1488

### DYNABRADE EUROPE S.à r.l.

6, OP Tomm | L-5485 Wormeldange-Haut | Luxembourg  
PH: +352 768 494 1 | FAX: +352 768 495

### DYNABRADE INDIA Abrasive Power Tools Pvt Ltd.

EL-101. TC Industrial Area, MIDC Mahape | Electronic Zone, Navi Mumbai - 400710 Maharashtra, India  
PH: +91 22 6910 6600 | FAX: +91 22 6910 6666

**WE LISTEN. WE OBSERVE. WE INSPIRE.**

Re-Order No. 00001676\_R8



© DYNABRADE, INC.

8989 Sheridan Drive  
Clarence, New York 14031-1419



Tel: 716.631.0100

Fax: 716.631.2073

International Fax: 716.631.2524



**DYNABRADE.COM**